

1

Moteur à excitation série

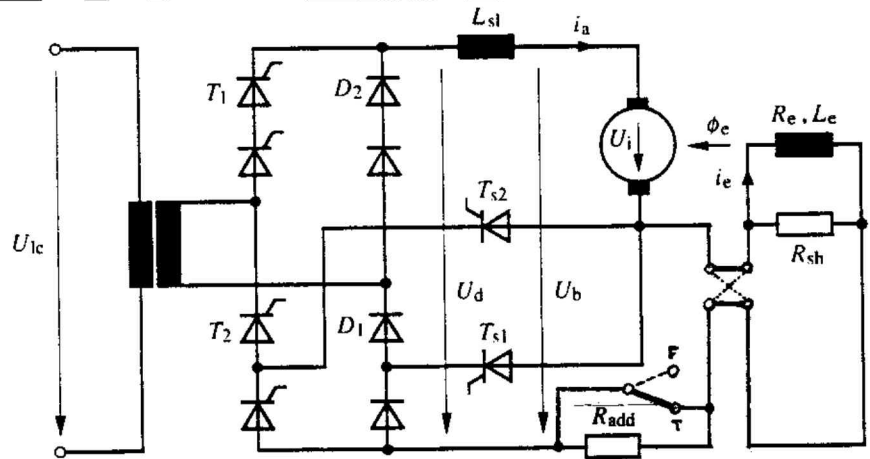

2

Moteur à excitation séparée

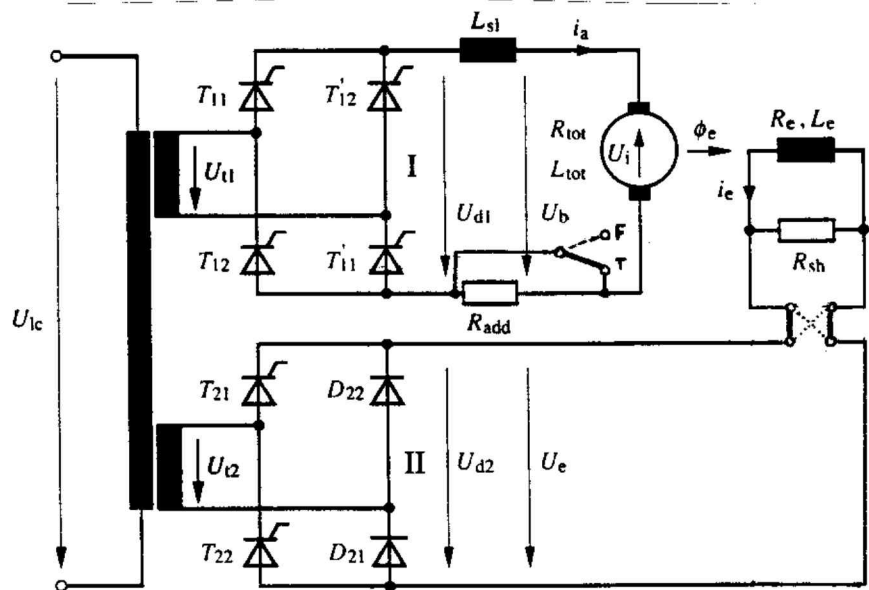

3

Moteur à excitation composite

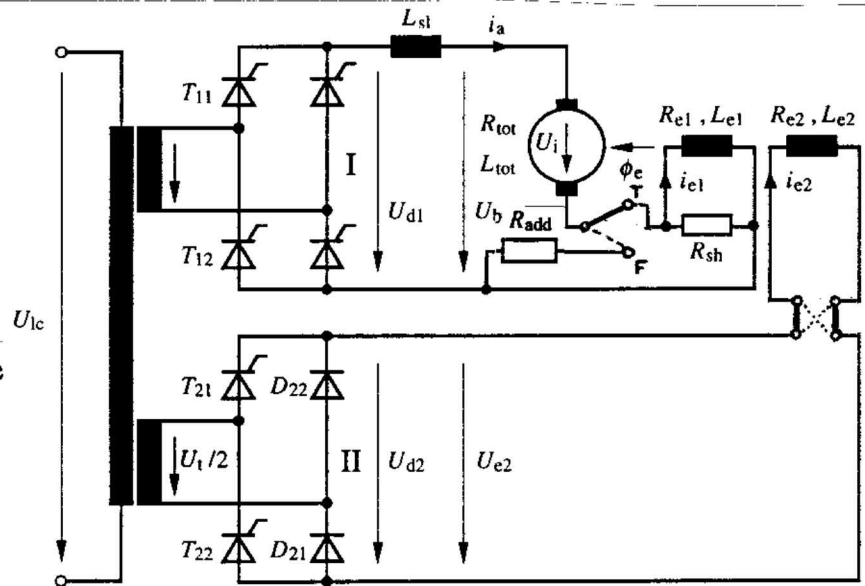

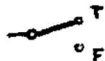
Commutateur traction-freinage 

Commutateur de sens de marche 

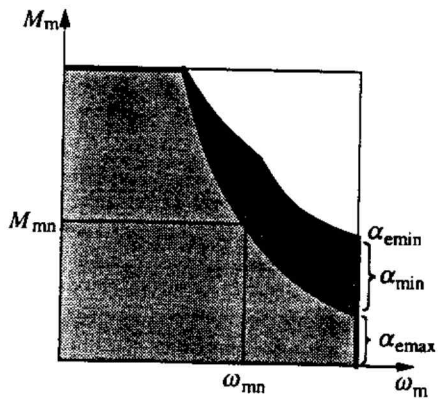

Traction (1 à 3)

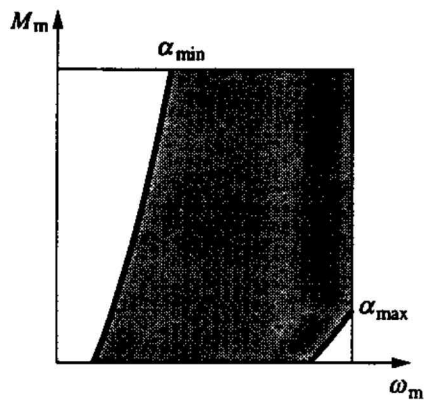

Freinage (1)

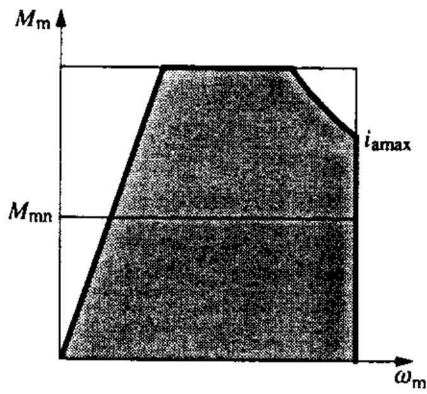

Freinage (2 et 3)